

# VIS À MÉTAL / METAL SCREW

## Type A, B, U, 25

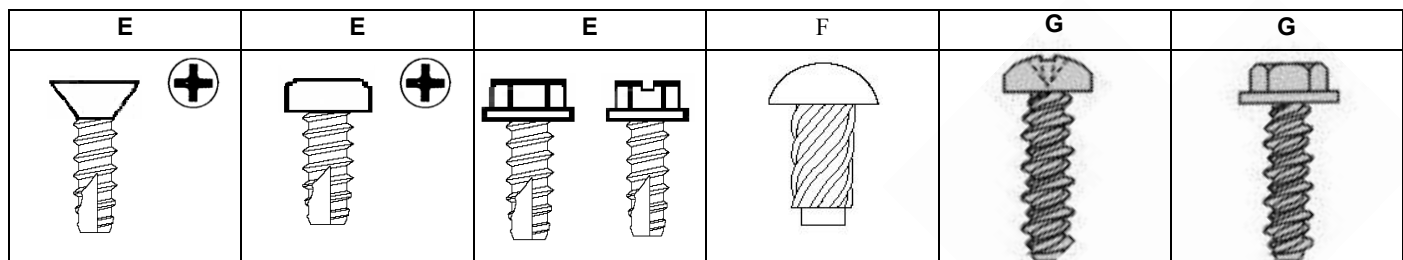
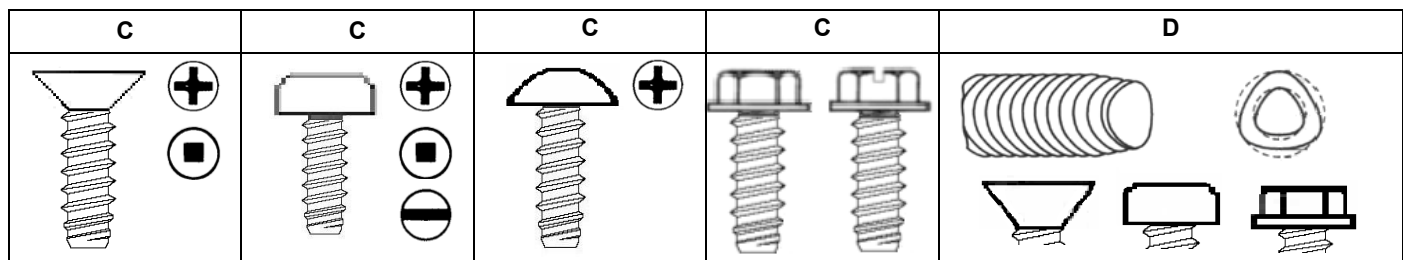
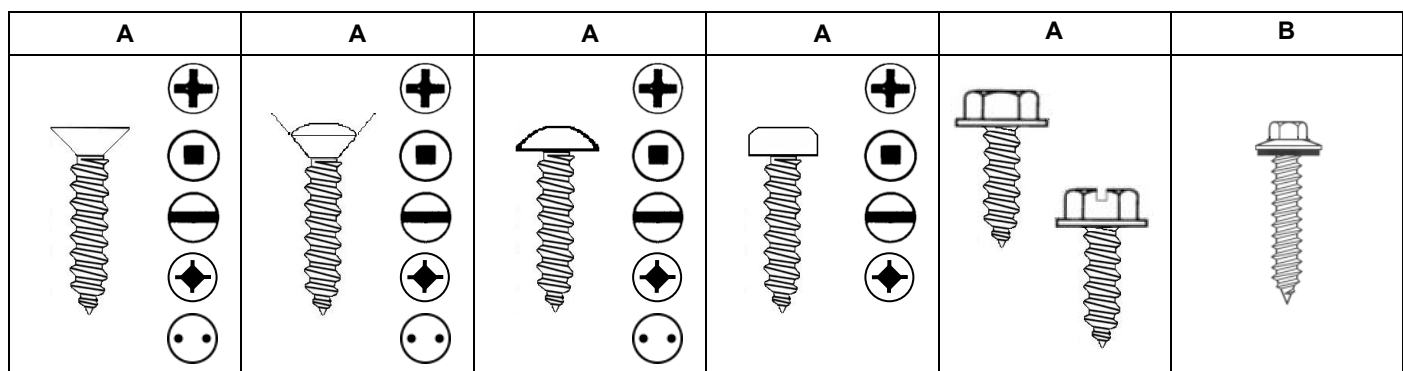

	Description		Page
A	Vis à métal Type A	Screw Type A Metal	515-529
A	Vis à métal Type A SPANNER	SPANNER Screw Type A Metal	531-532
B	Vis à panneau (Type A)	Screw Panel Grips (Type A)	530
C	Vis à métal Type B	Screw Type B Metal	533-540
D	Vis auto-taraudeuse triangulaire	Screw Thread Rolling	558-560
E	Vis auto-taraudeuse Type 25	Screw Type 25 Thread Cutting	556-557
F	Fausse vis Type U	Screw Type U Drive	549-550
G	Vis taraudeuse H-L	Screw Tapping High Low	575-576

# Vis à métal Type A Type A Metal Screw

## Tête fraisée Flat Head

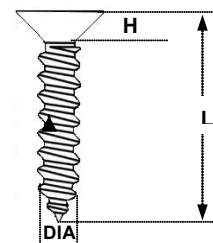
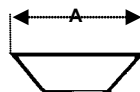

Prise Drive		Acier Zingué Steel Zinc Plated				Acier inoxydable Stainless Steel		Vrac Bulk	Boîte Pkg
		Rainurée Slotted	Phillips	Carrée/Square	Quadrex	Carrée/Square	Phillips		
DIA	L								
#2	1/4		0258 0212					10 000	100
	5/16		0258 0214					10 000	100
	3/8		0258 0216					10 000	100
	1/2		0258 0218					10 000	100
	5/8		0258 0220					10 000	100
	3/4		0258 0222					10 000	100
#4	3/16		0258 0408					10 000	100
	1/4		0258 0412				5068 0412	10 000	100
	5/16		0258 0414					10 000	100
	3/8		0258 0416	0217 0416		5073 0416	5068 0416	10 000	100
	1/2		0258 0418	0217 0418		5073 0418	5068 0418	10 000	100
	5/8		0258 0420	0217 0420		5073 0420	5068 0420	10 000	100
	3/4		0258 0422	0217 0422		5073 0422	5068 0422	10 000	100
	1		0258 0424			5073 0424	5068 0424	10 000	100
	1-1/4		0258 0426					6 000	100
	1-1/2		0258 0428					5 000	100
#5	3/8		0258 0516					10 000	100
	1/2		0258 0518	0217 0518				10 000	100
	5/8		0258 0520	0217 0520				9 000	100
	3/4		0258 0522	0217 0522				7 000	100
	1		0258 0524					6 000	100
#6	1/4		0258 0612				5068 0612	10 000	100
	3/8		0258 0616	0217 0616	0601 0616	5073 0616	5068 0616	10 000	100
	1/2		0258 0618	0217 0618	0601 0618	5073 0618	5068 0618	10 000	100
	5/8		0258 0620	0217 0620	0601 0620	5073 0620	5068 0620	9 000	100
	3/4		0258 0622	0217 0622	0601 0622	5073 0622	5068 0622	7 000	100
	7/8		0258 0623	0217 0623				7 000	100
	1		0258 0624	0217 0624	0601 0624	5073 0624	5068 0624	6 000	100
	1-1/4		0258 0626	0217 0626	0601 0626	5073 0626	5068 0626	5 000	100
	1-1/2		0258 0628	0217 0628	0601 0628	5073 0628	5068 0628	3 000	100
	1-3/4			0217 0630	0601 0630	5073 0630	5068 0630	2 500	100
2		0258 0632	0217 0632	0601 0632	5073 0632	5068 0632	2 000	100	
	2-1/2		0258 0636					2 000	100

	#2	#4	#5	#6
A	.172	.225	.252	.279
H	.051	.067	.075	.083

# Vis à métal Type A Type A Metal Screw

## Tête fraisée Flat Head

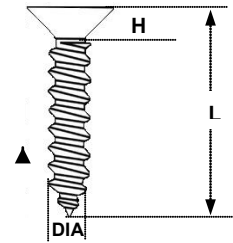
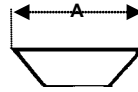

Prise Drive		Acier Zingué Steel Zinc Plated				Acier inoxydable Stainless Steel		Vrac Bulk	Boîte Pkg
		Rainurée Slotted	Phillips	Carrée/Square	Quadrex	Carrée/Square	Phillips		
DIA	L								
#7	5/8		0258 0720					6 000	100
	3/4		0258 0722					6 000	100
	7/8		0258 0723					4 000	100
	1		0258 0724					4 000	100
#8	1/4		0258 0812					8 000	100
	3/8		0258 0816	0217 0816	0601 0816	5073 0816	5068 0816	8 000	100
	1/2		0258 0818	0217 0818	0601 0818	5073 0818	5068 0818	7 000	100
	5/8		0258 0820	0217 0820	0601 0820	5073 0820	5068 0820	6 000	100
	3/4		0258 0822	0217 0822	0601 0822	5073 0822	5068 0822	6 000	100
	7/8		0258 0823	0217 0823		5073 0823	5068 0823	5 000	100
	1		0258 0824	0217 0824	0601 0824	5073 0824	5068 0824	4 000	100
	1-1/8			0217 0825				3 000	100
	1-1/4		0258 0826	0217 0826	0601 0826	5073 0826	5068 0826	3 000	100
	1-1/2		0258 0828	0217 0828	0601 0828	5073 0828	5068 0828	2 500	100
	1-3/4		0258 0830	0217 0830	0601 0830	5073 0830	5068 0830	2 000	100
	2		0258 0832	0217 0832	0601 0832	5073 0832	5068 0832	1 800	100
	2-1/4			0217 0834				1 000	100
	2-1/2		0258 0836	0217 0836		5073 0836	5068 0836	1 000	100
3		0258 0840	0217 0840		5073 0840	5068 0840	800	100	
3-1/2		0258 0844			5073 0844		500	100	
4		0258 0846					500	100	
#10	3/8		0258 1016			5073 1016	5068 1016	5 000	100
	1/2		0258 1018	0217 1018		5073 1018	5068 1018	5 000	100
	5/8		0258 1020	0217 1020		5073 1020	5068 1020	4 000	100
	3/4		0258 1022	0217 1022		5073 1022	5068 1022	4 000	100
	7/8		0258 1023	0217 1023				3 000	100
	1		0258 1024	0217 1024		5073 1024	5068 1024	3 000	100
	1-1/4		0258 1026	0217 1026		5073 1026	5068 1026	2 000	100
	1-1/2		0258 1028*	0217 1028		5073 1028	5068 1028	2 000	100
	1-3/4		0258 1030	0217 1030		5073 1030	5068 1030	1 800	100
	2		0258 1032	0217 1032	0601 1032	5073 1032	5068 1032	1 500	100
	2-1/4		0258 1034					1 000	100
	2-1/2		0258 1036			5073 1036	5068 1036	900	100
	3		0258 1040			5073 1040	5068 1040	700	100
3-1/2		0258 1044			5073 1044	5068 1044	500	100	
4					5073 1048		300	100	

\* 0030 1028 Plaqué Nickel Plated

	#7	#8	#10
A	.305	.332	.385
H	.091	.100	.116

# Vis à métal Type A Type A Metal Screw

## Tête fraisée Flat Head

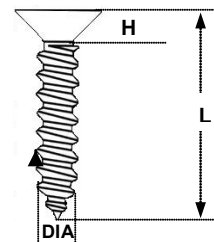
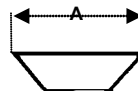



Prise Drive		Acier Zingué Steel Zinc Plated				Acier inoxydable Stainless Steel		Vrac Bulk	Boîte Pkg
		Rainurée Slotted	Phillips	Carrée/Square	Quadrex	Carrée/Square	Phillips		
DIA	L								
<b>#12</b>	1/2		0258 1218	0217 1218			5068 1218	10 000	100
	5/8		0258 1220	0217 1220				4 000	100
	3/4		0258 1222	0217 1222	0601 1222	5073 1222	5068 1222	3 000	100
	1		0258 1224	0217 1224	0601 1224	5073 1224	5068 1224	2 500	100
	1-1/4		0258 1226	0217 1226	0601 1226	5073 1226	5068 1226	2 000	100
	1-1/2		0258 1228	0217 1228	0601 1228	5073 1228	5068 1228	1 800	100
	1-3/4		0258 1230			5073 1230	5068 1230	1 500	100
	2		0258 1232	0217 1232	0601 1232	5073 1232	5068 1232	1 000	100
	2-1/2		0258 1236			5073 1236	5068 1236	800	100
	3		0258 1240			5073 1240	5068 1240	500	100
3-1/2		0258 1244			5073 1244		500	100	
4		0258 1248	0217 1248				500	100	
<b>#14</b> (1/4)	1/2		0258 2518				5068 2518	2 000	100
	5/8		0258 2520					1 800	100
	3/4		0258 2522	0217 2522	0601 2522	5073 2522	5068 2522	1 500	100
	1		0258 2524	0217 2524	0601 2524	5073 2524	5068 2524	1 000	100
	1-1/4		0258 2526	0217 2526	0601 2526	5073 2526	5068 2526	1 000	100
	1-1/2		0258 2528	0217 2528	0601 2528	5073 2528	5068 2528	1 000	100
	1-3/4			0217 2530		5073 2530	5068 2530	1 000	100
	2		0258 2532	0217 2532	0601 2532	5073 2532	5068 2532	900	100
	2-1/2		0258 2536			5073 2536	5068 2536	700	100
	3		0258 2540			5073 2540	5068 2540	500	100
3-1/2					5073 2544		500	100	
4		0258 2548			5073 2548		500	100	
<b>#20</b> (5/16)	1							500	100

	#12	#14	#20
A	.438	.507	
H	.132	.153	

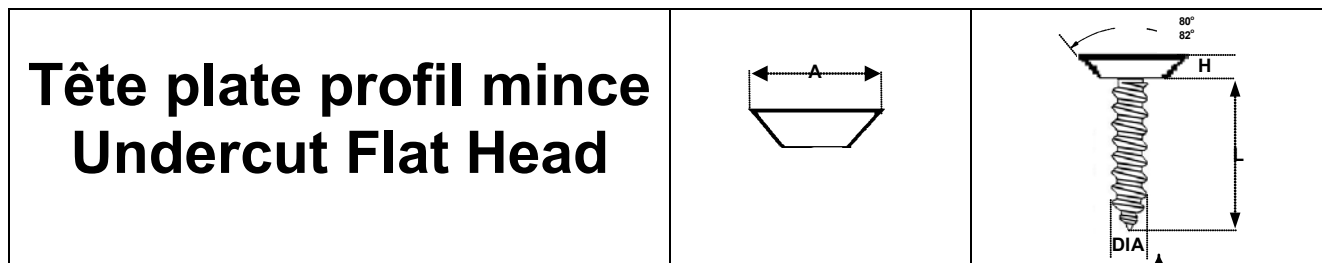
# Vis à métal Type A Type A Metal Screw



Prise Drive		Acier Zingué Steel Zinc Plated		Acier inoxydable Stainless Steel		Vrac Bulk	Boîte Pkg
		Rainurée Slotted 	Phillips 	Phillips 			
DIA	L						
#2	3/16					10 000	100
#4	3/16					10 000	100
	1/4					10 000	100
	3/8					10 000	100
#6	1/4					10 000	100
	3/8					10 000	100
	1/2					10 000	100
	3/4					7 000	100
#8	1/4					10 000	100
	3/8					10 000	100
	1/2					7 000	100
	5/8					7 000	100
	3/4					6 000	100
	1					4 000	100
#10	3/8					5 000	100
	1/2			0463 1018		5 000	100
	5/8					4 000	100
	3/4					4 000	100
	1					3 000	100
	1-1/4					2 000	100
#12	1/2					4 000	100
	3/4					3 000	100
	1					2 500	100
	1-1/4					2 000	100
#14	1/2					2 000	100
	5/8					2 000	100
	3/4					2 000	100
	1					1 000	100

	#2	#4	#6	#8	#10	#12	#14
A	.172	.225	.279	.332	.385	.438	.507
H	.036	.047	.059	.070	.081	.092	.107

# Vis à métal Type A

## Type A Metal Screw

### Tête ovale

### Oval Head

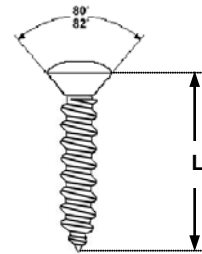
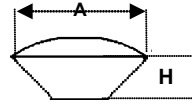

Prise Drive		Acier Zingué Steel Zinc Plated				Acier inoxydable Stainless Steel		Vrac Bulk	Boîte Pkg
		Rainurée Slotted	Phillips	Carrée/Square	Quadrex	Carrée/Square	Phillips		
DIA	L								
#2	3/8							10 000	100
#4	1/4		0259 0412				5069 0412	10 000	100
	5/16		0259 0414					10 000	100
	3/8		0259 0416			5074 0416	5069 0416	10 000	100
	7/16		0259 0417					10 000	100
	1/2		0259 0418			5074 0418	5069 0418	10 000	100
	5/8		0259 0420			5074 0420	5069 0420	10 000	100
	3/4		0259 0422			5074 0422	5069 0422	10 000	100
	7/8		0259 0423					10 000	100
1		0259 0424			5074 0424	5069 0424	10 000	100	
#5	1/2		0259 0518					10 000	100
	5/8		0259 0520					9 000	100
	3/4		0259 0522					8 000	100
#6	1/4						5069 0612	10 000	100
	3/8		0259 0616				5069 0616	10 000	100
	1/2		0259 0618			5074 0618	5069 0618	10 000	100
	5/8		0259 0620			5074 0620	5069 0620	9 000	100
	3/4		0259 0622			5074 0622	5069 0622	7 000	100
	7/8		0259 0623					7 000	100
	1		0259 0624			5074 0624	5069 0624	6 000	100
	1-1/4		0259 0626			5074 0626	5069 0626	5 000	100
	1-1/2		0259 0628			5074 0628	5069 0628	3 000	100
	2		0259 0632			5074 0632	5069 0632	2 000	100
3		0259 0640					1 000	100	
#8	3/8		0259 0816			5074 0816	5069 0816	8 000	100
	1/2		0259 0818			5074 0818	5069 0818	7 000	100
	5/8		0259 0820			5074 0820	5069 0820	6 000	100
	3/4		0259 0822	0032 0822		5074 0822	5069 0822	6 000	100
	7/8		0259 0823					5 000	100
	1		0259 0824	0032 0824		5074 0824	5069 0824	4 000	100
	1-1/4		0259 0826			5074 0826	5069 0826	8 000	100
	1-1/2		0259 0828			5074 0828	5069 0828	7 000	100
	1-3/4		0259 0830			5074 0830	5069 0830	6 000	100
	2		0259 0832			5074 0832	5069 0832	6 000	100
	2-1/4		0259 0834					5 000	100
	2-1/2		0259 0836			5074 0836	5069 0836	4 000	100
	3		0259 0840			5074 0840	5069 0840	3 000	100

	#2	#4	#5	#6	#8
A	.172	.225	.252	.279	.332
H	.080	.104	.116	.128	.152

# Vis à métal Type A

## Type A Metal Screw

### Tête ovale

### Oval Head

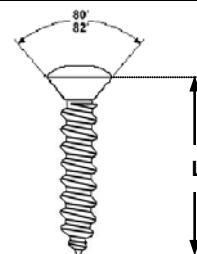
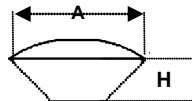

#### Acier Zingué

#### Steel Zinc Plated

#### Acier inoxydable

#### Stainless Steel

Prise Drive		Rainurée Slotted	Phillips	Carrée/Square	Quadrex	Carrée/Square	Phillips	Vrac Bulk	Boîte Pkg
DIA	L								
#10	3/8					5074 1016	5069 1016	5 000	100
	1/2		0259 1018			5074 1018	5069 1018	5 000	100
	5/8		0259 1020			5074 1020	5069 1020	4 000	100
	3/4		0259 1022	0903 1022		5074 1022	5069 1022	4 000	100
	7/8		0259 1023					3 000	100
	1		0259 1024*	0032 1024		5074 1024	5069 1024	3 000	100
	1-1/4		0259 1026			5074 1026	5069 1026	2 000	100
	1-1/2		0259 1028	0903 1028		5074 1028	5069 1028	2 000	100
	1-3/4		0259 1030			5074 1030	5069 1030	1 800	100
	2		0259 1032			5074 1032	5069 1032	1 000	100
	2-1/4							1 000	100
	2-1/2		0259 1036			5074 1036	5069 1036	900	100
	3		0259 1040			5074 1040	5069 1040	700	100
	3-1/2					5074 1044		500	100
4					5074 1048		300	100	
#12	1/2		0259 1218				5069 1218	4 000	100
	3/4		0259 1222			5074 1222	5069 1222	3 000	100
	1		0259 1224			5074 1224	5069 1224	2 500	100
	1-1/4		0259 1226			5074 1226	5069 1226	2 000	100
	1-1/2		0259 1228			5074 1228	5069 1228	1 800	100
	1-3/4		0259 1230					1 500	100
	2		0259 1232				5069 1232	1 000	100
	2-1/2		0259 1236				5069 1236	900	100
	3		0259 1240				5069 1240	700	100
#14	1/2		0259 2518				5069 2518	2 000	100
	3/4		0259 2522			5074 2522	5069 2522	2 000	100
	1		0259 2524			5074 2524	5069 2524	1 000	100
	1-1/4		0259 2526				5069 2526	1 000	100
	1-1/2		0259 2528				5069 2528	1 000	100
	1-3/4						5069 2530	900	100
	2		0259 2532				5069 2532	900	100
	2-1/2		0259 2536				5069 2536	700	100
	3		0259 2540				5069 2540	500	100

\* 0031 1024 Plaqué Nickel Plated

	#10	#12	#14
A	.385	.438	.507
H	.176	.200	.232

# Vis à métal Type A Type A Metal Screw

## Tête tronconique Pan Head

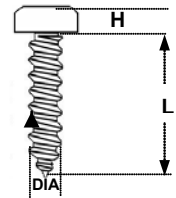
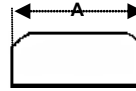

Prise Drive		Acier Zingué Steel Zinc Plated				Acier inoxydable Stainless Steel		Vrac Bulk	Boîte Pkg
		Rainurée Slotted	Phillips	Carrée/Square	Quadrex	Carrée/Square	Phillips		
DIA	L								
#2	1/8							10 000	100
	3/16		0260 0210					10 000	100
	1/4		0260 0212					10 000	100
	5/16		0260 0214					10 000	100
	3/8		0260 0216					10 000	100
	7/16		0260 0217					10 000	100
	1/2		0260 0218					10 000	100
	5/8		0260 0220					10 000	100
	3/4		0260 0222					10 000	100
1		0260 0224					10 000	100	
#4	1/8							10 000	100
	3/16		0260 0408					10 000	100
	1/4	0227 0412	0260 0412	0216 0412		5072 0412	5067 0412	10 000	100
	5/16		0260 0414	0216 0414				10 000	100
	3/8	0227 0416	0260 0416	0216 0416		5072 0416	5067 0416	10 000	100
	7/16		0260 0417					10 000	100
	1/2	0227 0418	0260 0418	0216 0418		5072 0418	5067 0418	10 000	100
	5/8	0227 0420	0260 0420	0216 0420		5072 0420	5067 0420	10 000	100
	3/4	0227 0422	0260 0422	0216 0422		5072 0422	5067 0422	10 000	100
	7/8		0260 0423					10 000	100
	1		0260 0424	0216 0424		5072 0424	5067 0424	10 000	100
1-1/4		0260 0426			5072 0426	5067 0426	8 000	100	
1-1/2		0260 0428			5072 0428	5067 0428	7 000	100	
#5	1/4							10 000	100
	3/8		0260 0516					10 000	100
	1/2		0260 0518					9 000	100
	5/8		0260 0520					7 000	100
	3/4		0260 0522					6 000	100
	1		0260 0524					5 000	100
1-1/4		0260 0526					5 000	100	

	#2	#4	#5
A	.167	.219	.245
H	.062	.080	.089



# Vis à métal Type A

## Type A Metal Screw

### Tête tronconique Pan Head

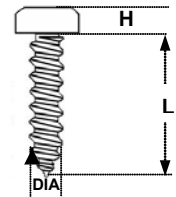
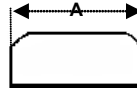

		Acier Zingué Steel Zinc Plated				Acier inoxydable Stainless Steel			
Prise Drive	Rainurée Slotted	Phillips	Carrée/ Square	Quadrex	Carrée/ Square	Phillips	Vrac Bulk	Boîte Pkg	
#6	3/16		0260 0608				10 000	100	
	1/4	0227 0612	0260 0612	0216 0612		5067 0612	10 000	100	
	5/16		0260 0614	0216 0614	0600 0614	5067 0614	10 000	100	
	3/8	0227 0616	0260 0616	0216 0616	0600 0616	5072 0616	5067 0616	10 000	100
	7/16		0260 0617					10 000	100
	1/2	0227 0618	0260 0618	0216 0618	0600 0618	5072 0618	5067 0618	10 000	100
	5/8	0227 0620	0260 0620	0216 0620	0600 0620	5072 0620	5067 0620	9 000	100
	3/4	0227 0622	0260 0622	0216 0622	0600 0622	5072 0622	5067 0622	7 000	100
	7/8		0260 0623	0216 0623				7 000	100
	1	0227 0624	0260 0624	0216 0624	0600 0624	5072 0624	5067 0624	6 000	100
	1-1/4	0227 0626	0260 0626	0216 0626	0600 0626	5072 0626	5067 0626	5 000	100
	1-1/2		0260 0628	0216 0628	0600 0628	5072 0628	5067 0628	3 000	100
	1-3/4		0260 0630	0216 0630				2 500	100
2		0260 0632	0216 0632		5072 0632	5067 0632	2 000	100	
2-1/2		0260 0636					2 000	100	
#7	3/8	0227 0716	0260 0716	0216 0716			7 000	100	
	1/2	0227 0718	0260 0718	0216 0718			6 000	100	
	5/8	0227 0720		0216 0720			6 000	100	
	3/4	0227 0722	0260 0722	0216 0722			4 000	100	
	1	0227 0724	0260 0724	0216 0724			3 000	100	
#8	3/16		0260 0808				10 000	100	
	1/4		0260 0812			5067 0812	10 000	100	
	5/16		0260 0814				9 000	100	
	3/8	0227 0816	0260 0816	0216 0816	0600 0816	5072 0816	5067 0816	8 000	100
	7/16		0260 0817					8 000	100
	1/2	0227 0818	0260 0818	0216 0818	0600 0818	5072 0818	5067 0818	7 000	100
	5/8	0227 0820	0260 0820	0216 0820	0600 0820	5072 0820	5067 0820	6 000	100
	3/4	0227 0822	0260 0822	0216 0822	0600 0822	5072 0822	5067 0822	6 000	100
	7/8	0227 0823	0260 0823	0216 0823				5 000	100
	1	0227 0824	0260 0824	0216 0824	0600 0824	5072 0824	5067 0824	4 000	100
	1-1/4	0227 0826	0260 0826	0216 0826	0600 0826	5072 0826	5067 0826	3 000	100
	1-1/2	0227 0828	0260 0828	0216 0828	0600 0828	5072 0828	5067 0828	2 500	100
	1-3/4		0260 0830	0216 0830		5072 0830	5067 0830	2 000	100
	2		0260 0832	0216 0832	0600 0832	5072 0832	5067 0832	1 500	100
2-1/2		0260 0836	0216 0836		5072 0836	5067 0836	1 000	100	
3		0260 0840	0216 0840		5072 0840	5067 0840	800	100	

	#6	#7	#8
A	.270	.296	.322
H	.097	.106	.115

# Vis à métal Type A Type A Metal Screw

## Tête tronconique Pan Head

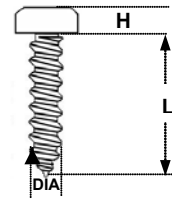
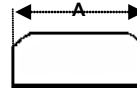

		Acier Zingué Steel Zinc Plated				Acier inoxydable Stainless Steel			
Prise Drive	Rainurée Slotted	Phillips	Carrée/ Square	Quadrex	Carrée/ Square	Phillips	Vrac Bulk	Boîte Pkg	
#10	1/4		0260 1012				5 000	100	
	3/8	0227 1016	0260 1016*	0216 1016	0600 1016	5072 1016	5067 1016	5 000	100
	1/2	0227 1018	0260 1018	0216 1018	0600 1018	5072 1018	5067 1018	5 000	100
	5/8	0227 1020	0260 1020	0216 1020	0600 1020	5072 1020	5067 1020	4 000	100
	3/4	0227 1022	0260 1022*	0216 1022	0600 1022	5072 1022	5067 1022	4 000	100
	7/8		0260 1023	0216 1023				3 000	100
	1	0227 1024	0260 1024	0216 1024	0600 1024	5072 1024	5067 1024	3 000	100
	1-1/8		0260 1025					3 000	100
	1-1/4	0227 1026	0260 1026	0216 1026	0600 1026	5072 1026	5067 1026	2 000	100
	1-1/2	0227 1028	0260 1028	0216 1028	0600 1028	5072 1028	5067 1028	2 000	100
	1-3/4	0227 1030	0260 1030	0216 1030		5072 1030	5067 1030	1 800	100
	2	0227 1032	0260 1032	0216 1032	0600 1032	5072 1032	5067 1032	1 000	100
	2-1/4							900	100
	2-1/2	0227 1036	0260 1036	0216 1036		5072 1036	5067 1036	900	100
	2-3/4		0260 1038					800	100
	3		0260 1040	0216 1040		5072 1040	5067 1040	700	100
3-1/2					5072 1044		600	100	
4		0260 1048			5072 1048		500	100	
#12	3/8		0260 1216					4 000	100
	1/2	0227 1218	0260 1218	0216 1218		5072 1218	5067 1218	4 000	100
	5/8	0227 1220	0260 1220	0216 1220	0600 1220			4 000	100
	3/4	0227 1222	0260 1222	0216 1222	0600 1222	5072 1222	5067 1222	3 000	100
	7/8		0260 1223					3 000	100
	1	0227 1224	0260 1224	0216 1224	0600 1224	5072 1224	5067 1224	2 500	100
	1-1/4	0227 1226	0260 1226	0216 1226	0600 1226	5072 1226	5067 1226	2 000	100
	1-1/2	0227 1228	0260 1228	0216 1228	0600 1228	5072 1228	5067 1228	1 800	100
	1-3/4		0260 1230	0216 1230	0600 1230	5072 1230		1 500	100
	2		0260 1232	0216 1232	0600 1232	5072 1232	5067 1232	1 000	100
	2-1/4							1 000	100
	2-1/2		0260 1236	0216 1236		5072 1236	5067 1236	800	100
	2-3/4							700	100
	3		0260 1240	0216 1240		5072 1240	5067 1240	500	100
	3-1/2		0260 1244			5072 1244		500	100
	4							300	100





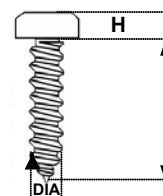
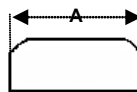

\* (10 X 3/8 - 0742 1016) Zingué noir / Black Zinc  
(10 X 3/4 - 0742 1022) Zingué noir / Black Zinc

	#10	#12
A	.373	.425
H	.133	.151

# Vis à métal Type A Type A Metal Screw

## Tête tronconique Pan Head







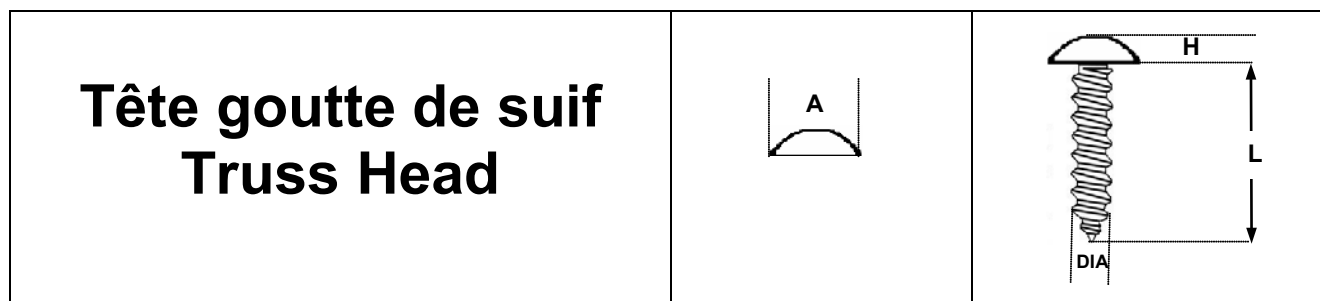

		Acier Zingué Steel Zinc Plated				Acier inoxydable Stainless Steel			
Prise Drive	Rainurée Slotted	Phillips	Carrée/ Square	Quadrex	Carrée/ Square	Phillips	Vrac Bulk	Boîte Pkg	
									
#14	3/8		0260 2516				3 000	100	
	1/2	0227 2518	0260 2518	0216 2518		5072 2518	5067 2518	3 000	100
	5/8	0227 2520	0260 2520	0216 2520				2 000	100
	3/4	0227 2522	0260 2522	0216 2522	0600 2522	5072 2522	5067 2522	2 000	100
	7/8		0260 2523					2 000	100
	1	0227 2524	0260 2524	0216 2524	0600 2524	5072 2524	5067 2524	1 000	100
	1-1/4	0227 2526	0260 2526	0216 2526	0600 2526	5072 2526	5067 2526	1 000	100
	1-1/2	0227 2528	0260 2528	0216 2528	0600 2528	5072 2528	5067 2528	1 000	100
	1-3/4	0227 2530	0260 2530	0216 2530		5072 2530	5067 2530	1 000	100
	2	0227 2532	0260 2532	0216 2532	0600 2532	5072 2532	5067 2532	900	100
	2-1/4							800	100
	2-1/2		0260 2536	0216 2536		5072 2536	5067 2536	700	100
	3		0260 2540	0216 2540		5072 2540	5067 2540	500	100
	3-1/2		0260 2544			5072 2544		500	100
4		0260 2548			5072 2548		300	100	
#20 (5/16)	1/2		0260 3118				2 000	100	
3/8	1		0260 3724				600	100	
	2						400	100	

	#14	#20	3/8
A	.492	.615	.740
H	.175	.218	.261

# Vis à métal Type A

## Type A Metal Screw







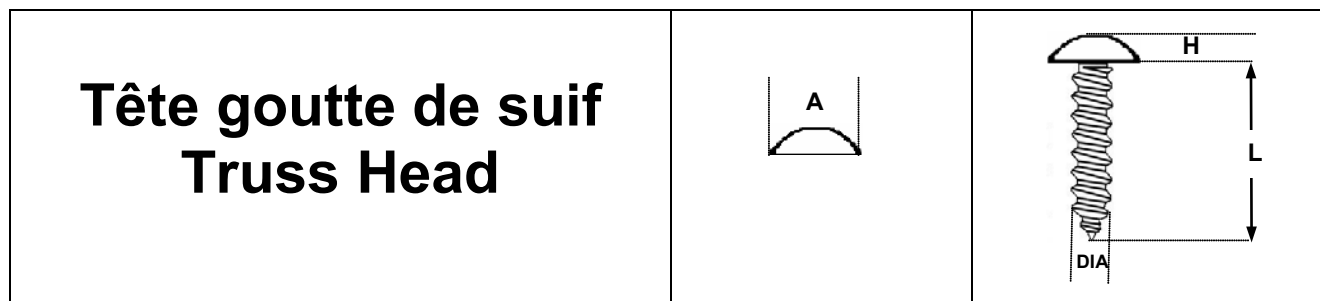

Prise Drive		Acier Zingué Steel Zinc Plated				Acier inoxydable Stainless Steel		Vrac Bulk	Boîte Pkg	
		Rainurée Slotted	Phillips	Carrée/Square	Quadrex	Carrée/Square	Phillips			
DIA	L									
<b>#4</b>	1/4		0261 0412					10 000	100	
	3/8		0261 0416			5075 0416	5070 0416	10 000	100	
	1/2		0261 0418			5075 0418	5070 0418	10 000	100	
<b>#6</b>	1/4		0261 0612					10 000	100	
	3/8		0261 0616	0228 0616		5075 0616	5070 0616	10 000	100	
	1/2		0261 0618	0228 0618		5075 0618	5070 0618	10 000	100	
	5/8		0261 0620	0228 0620		5075 0620	5070 0620	9 000	100	
	3/4		0261 0622	0228 0622		5075 0622	5070 0622	7 000	100	
	7/8							5 000	100	
	1			0261 0624	0228 0624		5075 0624	5070 0624	5 000	100
	1-1/4			0261 0626			5075 0626	5070 0626	5 000	100
<b>#8</b>	1/2		0261 0818	0228 0818		5075 0818	5070 0818	7 000	100	
	5/8		0261 0820	0228 0820		5075 0820	5070 0820	6 000	100	
	3/4		0261 0822	0228 0822		5075 0822	5070 0822	6 000	100	
	1		0261 0824	0228 0824		5075 0824	5070 0824	4 000	100	
	1-1/4		0261 0826	0228 0826		5075 0826	5070 0826	3 000	100	
	1-1/2		0261 0828	0228 0828		5075 0828	5070 0828	2 500	100	
	1-3/4		0261 0830			5075 0830	5070 0830	1 500	100	
	2		0261 0832	0228 0832		5075 0832	5070 0832	1 500	100	
	2-1/2					5075 0836	5070 0836	1 000	100	
	3					5075 0840	5070 0840	900	100	

	<b>#4</b>	<b>#6</b>	<b>#8</b>
<b>A</b>	.257	.321	.384
<b>H</b>	.069	.086	.102

# Vis à métal Type A

## Type A Metal Screw



		Acier Zingué Steel Zinc Plated				Acier inoxydable Stainless Steel			
Prise Drive	Rainurée Slotted	Phillips	Carrée/ Square	Quadrex	Carrée/ Square	Phillips	Vrac Bulk	Boîte Pkg	
									
<b>#10</b>	3/8		0261 1016	0228 1016		5075 1016	5070 1016	5 000	100
	1/2		0261 1018	0228 1018		5075 1018	5070 1018	5 000	100
	5/8		0261 1020	0228 1020		5075 1020	5070 1020	4 000	100
	3/4		0261 1022	0228 1022		5075 1022	5070 1022	4 000	100
	7/8		0261 1023					3 000	100
	1		0261 1024	0228 1024		5075 1024	5070 1024	3 000	100
	1-1/4		0261 1026	0228 1026		5075 1026	5070 1026	2 000	100
	1-1/2		0261 1028	0228 1028		5075 1028	5070 1028	2 000	100
	1-3/4						5070 1030	2 000	100
	2		0261 1032	0228 1032			5070 1032	1 000	100
	2-1/2						5070 1036	900	100
3						5070 1040	700	100	
<b>#12</b>	1/2		0261 1218*				5070 1218	4 000	100
	3/4		0261 1222*	0228 1222			5070 1222	3 000	100
	1		0261 1224*	0228 1224			5070 1224	2 500	100
	1-1/4		0261 1226				5070 1226	2 000	100
	1-1/2		0261 1228	0228 1228			5070 1228	1 500	100
	2		0261 1232				5070 1232	1 000	100
	2-1/2						5070 1236	900	100
3						5070 1240	800	100	
<b>#14</b>	1/2						5070 2518	2 000	100
	3/4		0261 2522				5070 2522	1 000	100
	1		0261 2524				5070 2524	1 000	100
	1-1/4			0228 1426			5070 2526	1 000	100
	1-1/2		0261 2528				5070 2528	900	100
	1-3/4						5070 2530	900	100
2						5070 2532	900	100	

\* (12 X 1/2 - 0033 1218) Plaqué Nickel Plated  
 (12 X 3/4 - 0033 1222) Plaqué Nickel Plated  
 (12 X 1 - 0033 1224) Plaqué Nickel Plated

	#10	#12	#14
A	.448	.511	.573
H	.118	.134	.150

# Vis à métal Type A Type A Metal Screw

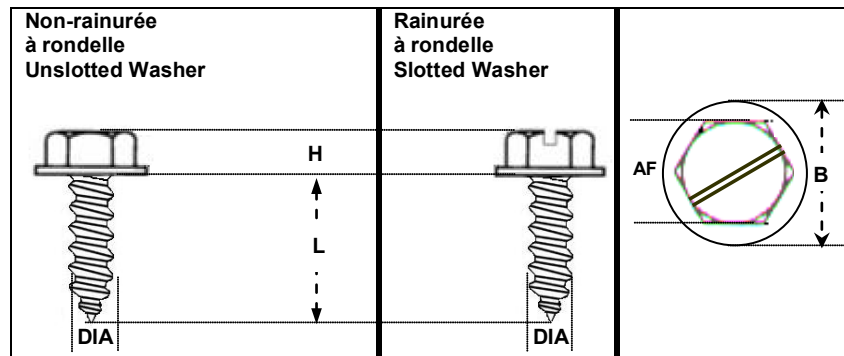

DIA	L	Acier zingué Steel Zinc Plated	Acier inoxydable Stainless Steel	Acier zingué Steel Zinc Plated	Vrac Bulk	Boîte Pkg
<b>#4</b>	1/4	0918 0412			10 000	100
	5/16				10 000	100
	3/8	0918 0416			10 000	100
	1/2	0918 0418			10 000	100
	5/8				10 000	100
	3/4	0918 0422			10 000	100
1					10 000	100
<b>#6</b>	1/4	0918 0612		0215 0612	10 000	100
	5/16	0918 0614			10 000	100
	3/8	0918 0616		0215 0616	10 000	100
	1/2	0918 0618		0215 0618	10 000	100
	5/8	0918 0620		0215 0620	9 000	100
	3/4	0918 0622		0215 0622	7 000	100
	1	0918 0624		0215 0624	5 000	100
	1-1/4	0918 0626		0215 0626	4 000	100
	1-1/2	0918 0628		0215 0628	3 000	100
	2	0918 0632		0215 0632	2 000	100
<b>#8</b>	1/4	0918 0812			10 000	100
	5/16	0918 0814			8 000	100
	3/8	0918 0816		0215 0816	8 000	100
	1/2	0918 0818	5076 0818	0215 0818	7 000	100
	5/8	0918 0820		0215 0820	6 000	100
	3/4	0918 0822	5076 0822	0215 0822	6 000	100
	7/8	0918 0823			5 000	100
	1	0918 0824	5076 0824	0215 0824	4 000	100
	1-1/4	0918 0826	5076 0826	0215 0826	3 000	100
	1-1/2	0918 0828	5076 0828	0215 0828	2 500	100
	1-3/4	0918 0830			2 000	100
	2	0918 0832		0215 0832	1 500	100
	2-1/2	0918 0836		0215 0836	1 000	100
	3	0918 0840		0215 0840	800	100

	AF	B	H
<b>#4</b>	3/16	.243	.060
<b>#6</b>	1/4	.328	.093
<b>#8</b>	1/4	.348	.110

# Vis à métal Type A Type A Metal Screw

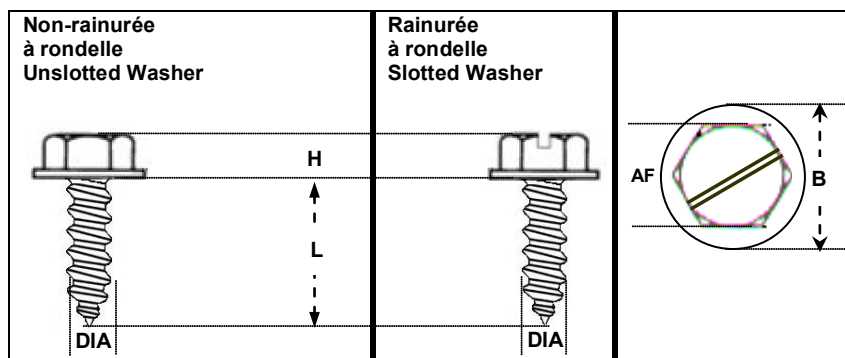

DIA	L	Acier zingué Steel Zinc Plated	Acier inoxydable Stainless Steel	Acier zingué Steel Zinc Plated	Vrac Bulk	Boîte Pkg
#10	1/4	0918 1012			5 000	100
	3/8	0918 1016		0215 1016	5 000	100
	1/2	0918 1018	5076 1018	0215 1018	5 000	100
	5/8	0918 1020		0215 1020	4 000	100
	3/4	0918 1022	5076 1022	0215 1022	4 000	100
	1	0918 1024	5076 1024	0215 1024	3 000	100
	1-1/4	0918 1026	5076 1026	0215 1026	2 000	100
	1-1/2	0918 1028	5076 1028	0215 1028	1 800	100
	2	0918 1032		0215 1032	1 000	100
	2-1/2	0918 1036		0215 1036	900	100
	3	0918 1040		0215 1040	500	100
4	0918 1048		0215 1048	500	100	
#12	1/2	0918 1218	5076 1218	0215 1218	4 000	100
	5/8	0918 1220		0215 1220	4 000	100
	3/4	0918 1222	5076 1222	0215 1222	3 000	100
	1	0918 1224	5076 1224	0215 1224	2 500	100
	1-1/4	0918 1226	5076 1226	0215 1226	2 000	100
	1-1/2	0918 1228	5076 1228	0215 1228	2 000	100
	2	0918 1232	5076 1232	0215 1232	1 000	100
	2-1/2	0918 1236		0215 1236	800	100
	3	0918 1240		0215 1240	500	100
3-1/2	0918 1244			500	100	
#14	3/8	0918 1416			3 000	100
	1/2	0918 1418	5076 2518	0215 2518	2 000	100
	5/8	0918 1420		0215 2520	2 000	100
	3/4	0918 1422	5076 2522	0215 2522	2 000	100
	1	0918 1424	5076 2524	0215 2524	1 000	100
	1-1/4	0918 1426	5076 2526	0215 2526	1 000	100
	1-1/2	0918 1428	5076 2528	0215 2528	1 000	100
	1-3/4	0918 1430		0215 2530	900	100
	2	0918 1432	5076 2532	0215 2532	900	100
	2-1/4	0918 1434			800	100
	2-1/2	0918 1436		0215 2536	700	100
	2-3/4			0215 2538	500	100
	3	0918 1440		0215 2540	500	100
	3-1/2	0918 1444			500	100
4	0918 1448		0215 2548	500	100	

	AF	B	H
#10	5/16	.414	.120
#12	5/16	.432	.155
#14	3/8	.520	.190

# Vis à métal Type A Type A Metal Screw

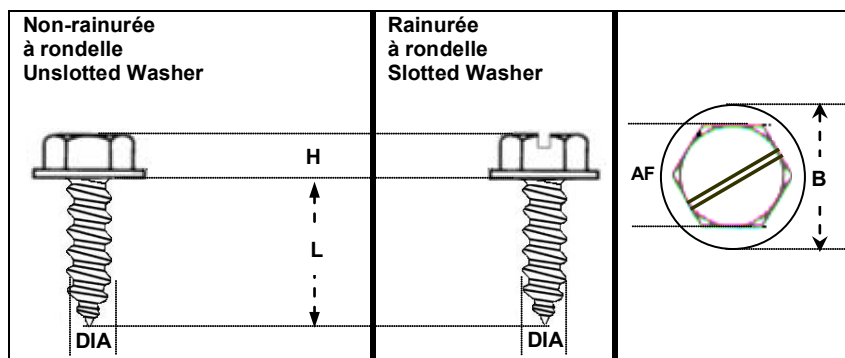

DIA	L	Acier zingué Steel Zinc Plated	Acier zingué Steel Zinc Plated	Acier inoxydable Stainless Steel	Vrac Bulk	Boîte Pkg
<b>#20</b> (5/16)	1/2	0918 3118	0215 3118		500	100
	5/8	0918 3120			500	100
	3/4	0918 3122	0215 3122		300	100
	1	0918 3124	0215 3124		300	100
	1-1/4	0918 3126	0215 3126		300	100
	1-1/2	0918 3128	0215 3128		300	100
	1-3/4	0918 3130	0215 3130		300	100
	2	0918 3132	0215 3132		200	100
	2-1/2	0918 3136	0215 3136		200	100
	3	0918 3140	0215 3140		200	100
<b>3/8</b>	1/2		0215 3718		600	100
	3/4	0918 3722	0215 3722		500	100
	1	0918 3724	0215 3724		500	100
	1-1/4	0918 3726	0215 3726		400	100
	1-1/2	0918 3728	0215 3728		400	100
	1-3/4	0691 3730			300	100
	2	0918 3732	0215 3732		300	100
	2-1/2	0918 3736	0215 3736		300	100
	3		0215 3740		200	100

	AF	B	H
<b>#20</b>	1/2	.676	.230
<b>3/8</b>	9/16	.780	.295



# Vis à panneau Type A Panel Grips Screw Type A

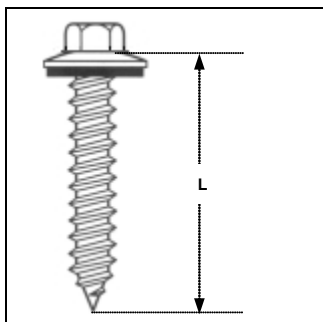

Acier Zingué / Steel Zinc Plated			
DIA \ L	#8	#10	#14
3/4			0226 2522
1	0226 0824	0226 1024	0226 2524
1-1/4			0226 2526
1-1/2	0226 0828	0226 1028	0226 2528
2	0226 0832	0226 1032	0226 2532
2-1/2		0226 1036	0226 2536
3		0226 1040	0226 2540
3-1/2			0226 2544
4			0226 2548
5			0226 2554
6			0226 2558

# Vis à métal Type A SPANNER SPANNER Type A Metal Screw

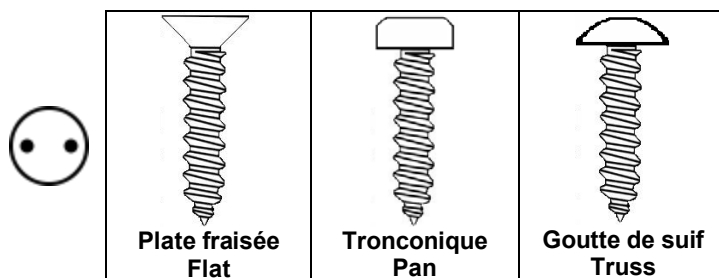

DIA	Lg	Acier inoxydable / Stainless Steel 18-8		
#4	1/4	5026 0412	5025 0412	
	3/8	5026 0416	5025 0416	
	1/2	5026 0418	5025 0418	
	3/4	5026 0422	5025 0422	
	1	5026 0424	5025 0424	
#6	1/4		5025 0612	
	3/8	5026 0616	5025 0616	
	1/2	5026 0618	5025 0618	
	5/8	5026 0620	5025 0620	
	3/4	5026 0622	5025 0622	
	1	5026 0624	5025 0624	
	1-1/4	5026 0626	5025 0626	
	1-1/2	5026 0628	5025 0628	
2	5026 0632	5025 0632		
#8	3/8	5026 0816	5025 0816	
	1/2	5026 0818	5025 0818	5024 0818
	5/8	5026 0820	5025 0820	
	3/4	5026 0822	5025 0822	5024 0822
	1	5026 0824	5025 0824	5024 0824
	1-1/4	5026 0826	5025 0826	5024 0826
	1-1/2	5026 0828	5025 0828	5024 0828
	1-3/4		5025 0830	
	2	5026 0832	5025 0832	

# Vis à métal Type A SPANNER

## SPANNER Type A Metal Screw

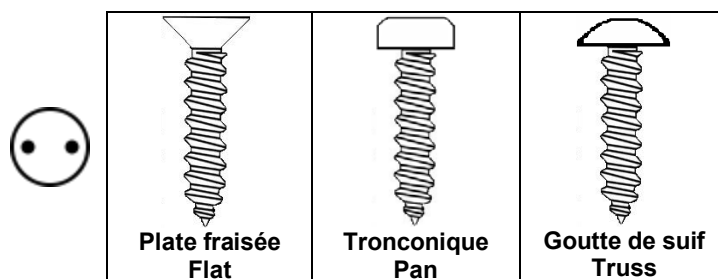

DIA	Lg	Acier inoxydable / Stainless Steel 18-8		
#10	3/8		5025 1016	5024 1016
	1/2	5026 1018	5025 1018	5024 1018
	5/8	5026 1020	5025 1020	
	3/4	5026 1022	5025 1022	5024 1022
	1	5026 1024	5025 1024	5024 1024
	1-1/4	5026 1026	5025 1026	5024 1026
	1-1/2	5026 1028	5025 1028	5024 1028
	1-3/4	5026 1030	5025 1030	
	2	5026 1032	5025 1032	5024 1032
#12	1/2	5026 1218	5025 1218	
	3/4	5026 1222	5025 1222	
	1	5026 1224	5025 1224	
	1-1/4	5026 1226	5025 1226	
	1-1/2	5026 1228	5025 1228	
	2	5026 1232	5025 1232	
#14	1/2	5026 2518	5025 2518	
	3/4	5026 2522	5025 2522	
	1	5026 2524	5025 2524	
	1-1/4	5026 2526	5025 2526	
	1-1/2	5026 2528	5025 2528	
	2	5026 2532	5025 2532	

# Vis à métal Type B

## Type B Metal Screw

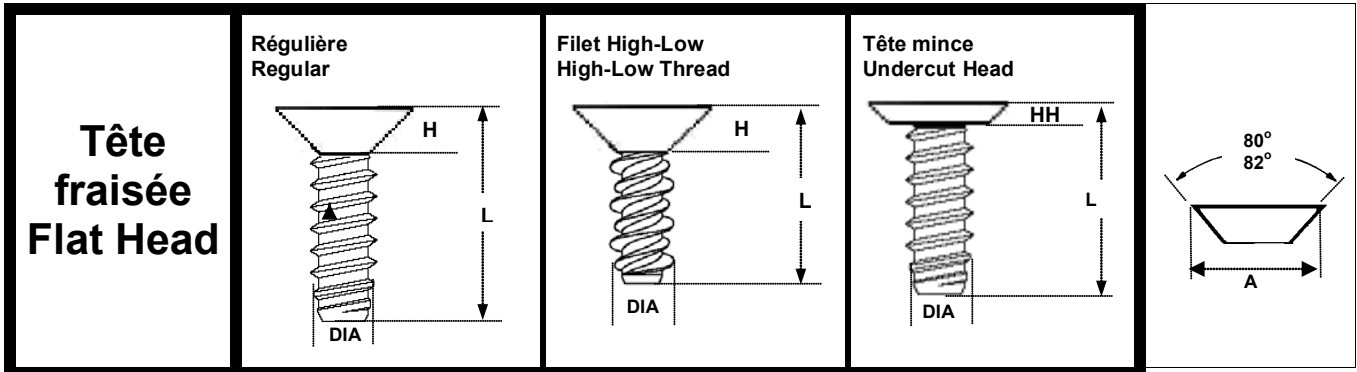

		Acier zingué Steel Zinc Plated		Acier zingué Steel Zinc Plated	Acier inoxydable Stainless Steel 410	Acier zingué Steel Zinc Plated			
DIA	L	Phillips	Carrée/ Square	Phillips	Phillips	Phillips	Carrée/ Square	Vrac Bulk	Boîte Pkg
		⊕	⊞	⊕	⊕	⊕	⊞		
<b>#2</b>	1/8	0262 0206						10 000	100
	3/16	0262 0210						10 000	100
	1/4	0262 0212						10 000	100
	5/16	0262 0214						10 000	100
	3/8	0262 0216						10 000	100
	7/16	0262 0217						10 000	100
	1/2	0262 0218						10 000	100
<b>#4</b>	3/16							10 000	100
	1/4	0262 0412						10 000	100
	5/16	0262 0414						10 000	100
	3/8	0262 0416						10 000	100
	1/2	0262 0418						10 000	100
	5/8	0262 0420						10 000	100
	3/4	0262 0422						10 000	100
	1	0262 0424						10 000	100
<b>#6</b>	1/4	0262 0612						10 000	100
	5/16	0262 0614						10 000	100
	3/8	0262 0616						10 000	100
	1/2	0262 0618						10 000	100
	5/8	0262 0620						10 000	100
	3/4	0262 0622						7 000	100
	1	0262 0624						6 000	100
	1-1/4	0262 0626						5 000	100
	1-1/2	0262 0628						3 500	100

	<b>#2</b>	<b>#4</b>	<b>#6</b>
<b>A</b>	.172	.225	.279
<b>H</b>	.051	.067	.083
<b>HH</b>			

# Vis à métal Type B

## Type B Metal Screw

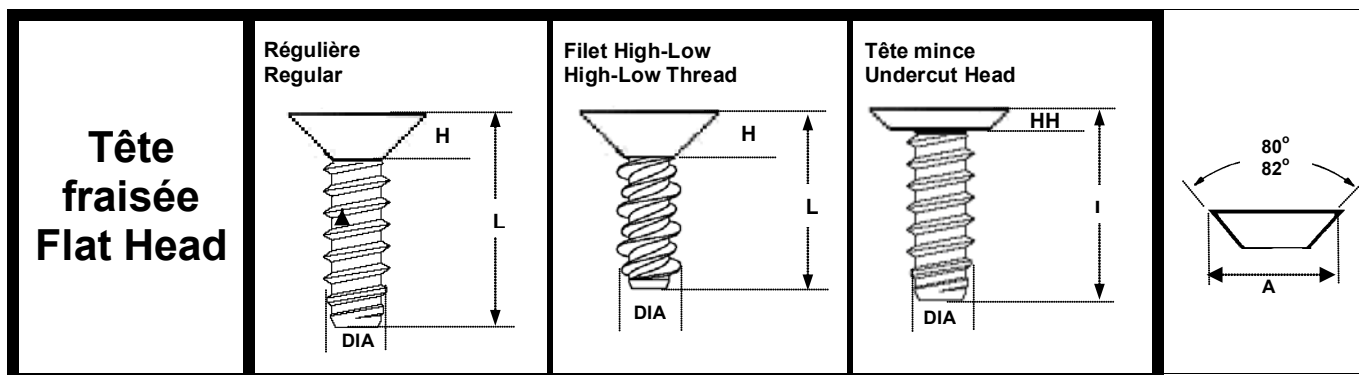

DIA	L	Acier zingué Steel Zinc Plated		Acier zingué Steel Zinc Plated	Acier inoxydable Stainless Steel 410	Acier zingué Steel Zinc Plated		Vrac Bulk	Boîte Pkg
		Phillips ⊕	Carrée/ Square ⊞	Phillips ⊕	Phillips ⊕	Phillips ⊕	Carrée/ Square ⊞		
		<b>#8</b>	1/4	0262 0812					
	3/8	0262 0816						8 000	100
	1/2	0262 0818				0744 0818		7 000	100
	5/8	0262 0820						6 000	100
	3/4	0262 0822						6 000	100
	7/8	0262 0823						5 000	100
	1	0262 0824						4 000	100
	1-1/4	0262 0826						3 000	100
	1-1/2	0262 0828						2 500	100
	1-3/4	0262 0830						2 000	100
	2	0262 0832						1 800	100
<b>#10</b>	3/8	0262 1016						5 000	100
	1/2	0262 1018	0239 1018				0745 1018	5 000	100
	5/8	0262 1020	0239 1020			0744 1020	0745 1020*	4 000	100
	3/4	0262 1022						4 000	100
	1	0262 1024						3 000	100
	1-1/4	0262 1026						3 000	100
	1-1/2	0262 1028						2 000	100
	1-3/4	0262 1030						2 000	100
	2	0262 1032						1 000	100
<b>#12</b>	1/2							4 000	100
	3/4							2 500	100
	1							2 500	100
<b>#14</b>	1/2	0262 2518						2 000	100
	3/4	0262 2522						2 000	100
	1	0262 2524						1 000	100
	1-1/4	0262 1426						1 000	100
	2							800	100

\* (10 X 5/8 - 0408 1020) Bronze

	#8	#10	#12	#14
A	.332	.385	.438	.507
H	.100	.116	.132	.153
HH				

# Vis à métal Type B

## Type B Metal Screw

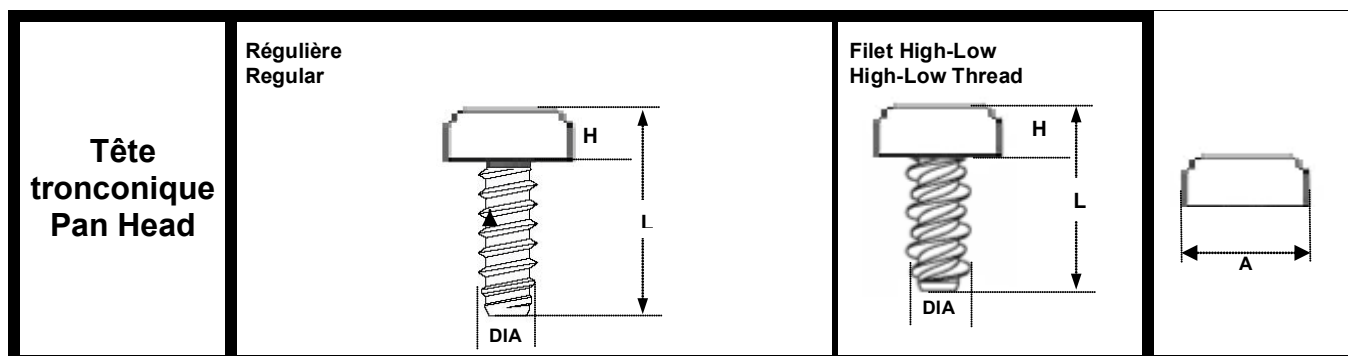

		Acier zingué Steel Zinc Plated			Acier inoxydable Stainless Steel 18-8	Acier zingué Steel Zinc Plated	Acier inoxydable Stainless Steel 410		
DIA	L	Rainurée Slotted ⊖	Phillips ⊕	Carrée/ Square ⊠	Phillips ⊕	Phillips ⊕	Phillips ⊕	Vrac Bulk	Boîte Pkg
<b>#2</b>	1/8		0263 0206					10 000	100
	3/16		0263 0210					10 000	100
	1/4		0263 0212					10 000	100
	5/16		0263 0214					10 000	100
	3/8		0263 0216					10 000	100
	1/2		0263 0218					10 000	100
	5/8		0263 0220					10 000	100
	3/4		0263 0222					10 000	100
1		0263 0224					10 000	100	
<b>#3</b>	1/4		0263 0312					10 000	100
<b>#4</b>	1/8							10 000	100
	3/16		0263 0408					10 000	100
	1/4		0263 0412					10 000	100
	5/16		0263 0414					10 000	100
	3/8		0263 0416					10 000	100
	7/16		0263 0417					10 000	100
	1/2		0263 0418					10 000	100
	5/8		0263 0420					10 000	100
	3/4		0263 0422					10 000	100
	7/8		0263 0423					10 000	100
	1		0263 0424					10 000	100
	1-1/4		0263 0426					6 000	100
1-1/2							4 000	100	
<b>#5</b>	1/4		0263 0512					10 000	100
	5/16		0263 0514					10 000	100
	3/8		0263 0516					10 000	100
	1/2		0263 0518					10 000	100
	5/8		0263 0520					10 000	100
	3/4		0263 0522					7 000	100

	#2	#3	#4	#5
A	.167	.193	.219	.245
H	.062	.071	.080	.089

# Vis à métal Type B

## Type B Metal Screw

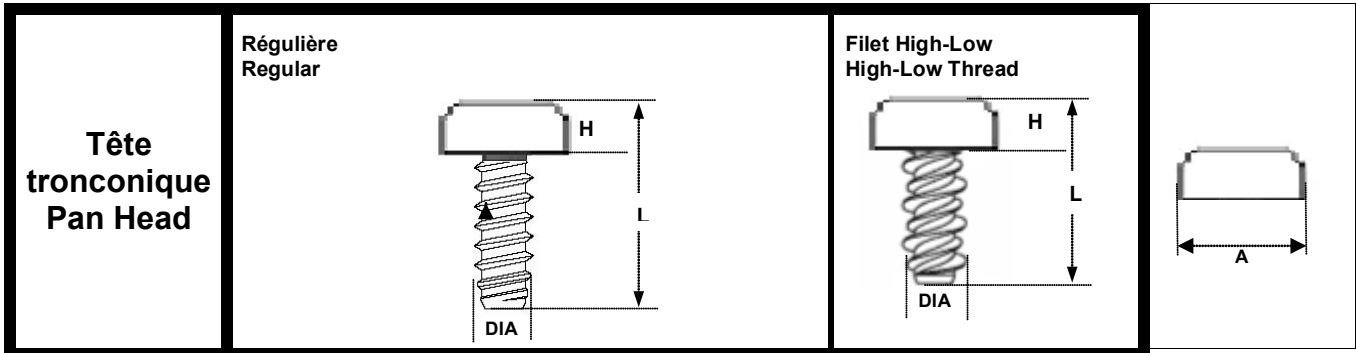

		Acier zingué Steel Zinc Plated			Acier inoxydable Stainless Steel 18-8	Acier zingué Steel Zinc Plated	Acier inoxydable Stainless Steel 410		
DIA	L	Rainurée Slotted	Phillips	Carrée/ Square	Phillips	Phillips	Phillips	Vrac Bulk	Boîte Pkg
		⊖	⊕	⊠	⊕	⊕	⊕		
<b>#6</b>	3/16		0263 0608					10 000	100
	1/4		0263 0612					10 000	100
	5/16		0263 0614					10 000	100
	3/8	0747 0616	0263 0616					10 000	100
	7/16		0263 0617					10 000	100
	1/2		0263 0618					10 000	100
	5/8		0263 0620					9 000	100
	3/4		0263 0622					7 000	100
	7/8		0263 0623					7 000	100
	1		0263 0624					6 000	100
	1-1/4		0263 0626					5 000	100
	1-1/2		0263 0628					4 000	100
1-3/4		0263 0630					2 500	100	
2		0263 0632					2 000	100	
<b>#8</b>	3/16							10 000	100
	1/4		0263 0812					10 000	100
	5/16		0263 0814					10 000	100
	3/8		0263 0816					10 000	100
	1/2	0747 0818	0263 0818	0976 0818				10 000	100
	5/8		0263 0820					6 000	100
	3/4		0263 0822					6 000	100
	7/8		0263 0823		0951 1023			5 000	100
	1		0263 0824					4 000	100
	1-1/4		0263 0826					3 000	100
	1-1/2		0263 0828					2 500	100
	1-3/4		0263 0830					2 000	100
2		0263 0832					1 800	100	

	<b>#6</b>	<b>#8</b>
<b>A</b>	.270	.322
<b>H</b>	.097	.115

# Vis à métal Type B

## Type B Metal Screw

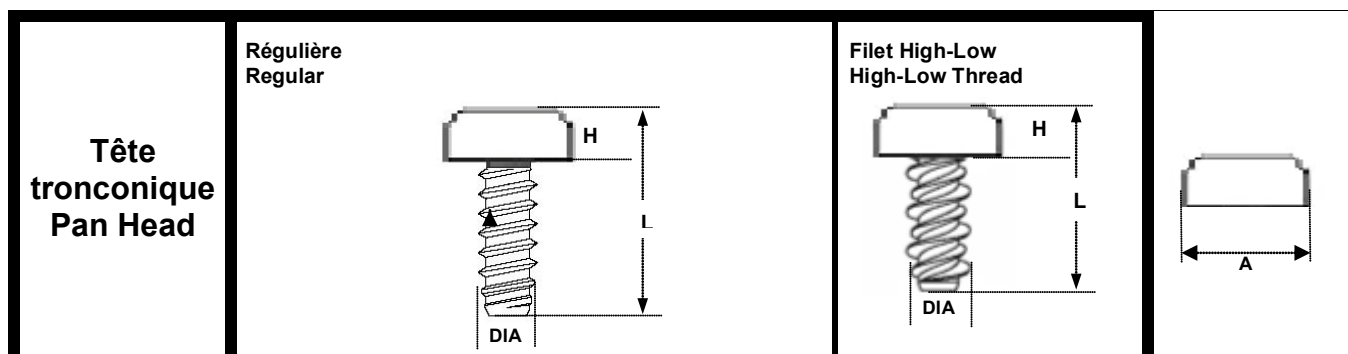

		Acier zingué Steel Zinc Plated			Acier inoxydable Stainless Steel 18-8	Acier zingué Steel Zinc Plated	Acier inoxydable Stainless Steel 410		
DIA	L	Rainurée Slotted ⊖	Phillips ⊕	Carrée/ Square ⊠	Phillips ⊕	Phillips ⊕	Phillips ⊕	Vrac Bulk	Boîte Pkg
<b>#10</b>	1/4		0263 1012					10 000	100
	5/16		0263 1014					10 000	100
	3/8	0747 1016	0263 1016		0951 1016			9 000	100
	1/2		0263 1018		0951 1018			5 000	100
	5/8		0263 1020					4 000	100
	3/4		0263 1022					4 000	100
	1		0263 1024					3 000	100
	1-1/4		0263 1026					3 000	100
	1-1/2		0263 1028					3 000	100
	1-3/4		0263 1030					2 000	100
	2		0263 1032					1 000	100
<b>#12</b>	3/8		0263 1216					10 000	100
	1/2		0263 1218					10 000	100
	5/8		0263 1220					10 000	100
	3/4		0263 1222					10 000	100
	1		0263 1224					6 000	100
	1-1/4		0263 1226					6 000	100
	1-1/2		0263 1228					5 000	100
<b>#14</b>	3/8							3 000	100
	1/2		0263 2518					3 000	100
	5/8		0263 2520					2 000	100
	3/4		0263 2522					2 000	100
	1		0263 2524					1 000	100
	1-1/4		0263 2526					1 000	100
	1-1/2		0263 2528					1 000	100
	1-3/4		0263 2530					1 000	100
	2		0263 2532					900	100

	<b>#10</b>	<b>#12</b>	<b>#14</b>
<b>A</b>	.373	.425	.492
<b>H</b>	.133	.151	.175



# Vis à métal Type B Type B Metal Screw

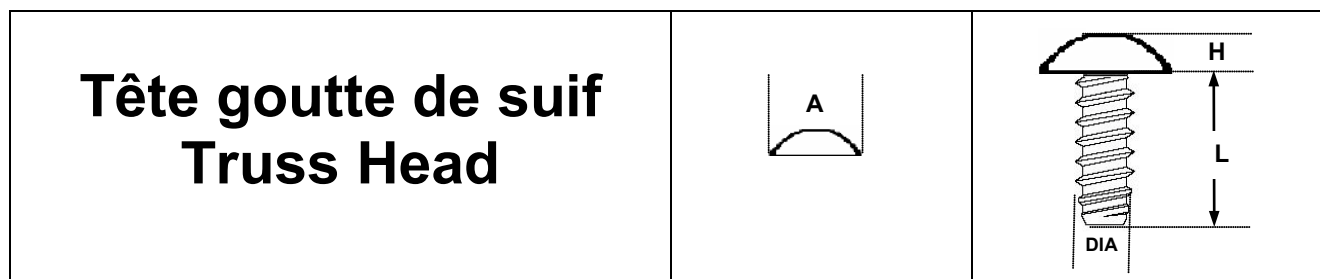

		Acier Zingué Steel Zinc Plated		
DIA	L	Phillips ⊕	Vrac Bulk	Boîte Pkg
<b>#4</b>	5/16		10 000	100
	3/8		10 000	100
<b>#6</b>	1/4	0264 0612	10 000	100
	3/8	0264 0616	10 000	100
	1/2	0264 0618	10 000	100
	5/8	0264 0620	9 000	100
	3/4	0264 0622	7 000	100
<b>#8</b>	1/4	0264 0812	10 000	100
	3/8	0264 0816	8 000	100
	1/2	0264 0818	8 000	100
	5/8	0264 0820	6 000	100
	3/4	0264 0822	6 000	100
<b>#10</b>	3/8	0264 1016	9 000	100
	1/2	0264 1018	8 000	100
	5/8	0264 1020	4 000	100
	3/4	0264 1022	4 000	100
	1	0264 1024	4 000	100
<b>#14</b>	3/4		2 000	100

	#4	#6	#8	#10	#14
A	.257	.321	.384	.448	.573
H	.069	.086	.102	.118	.150

# Vis à métal Type B

## Type B Metal Screw

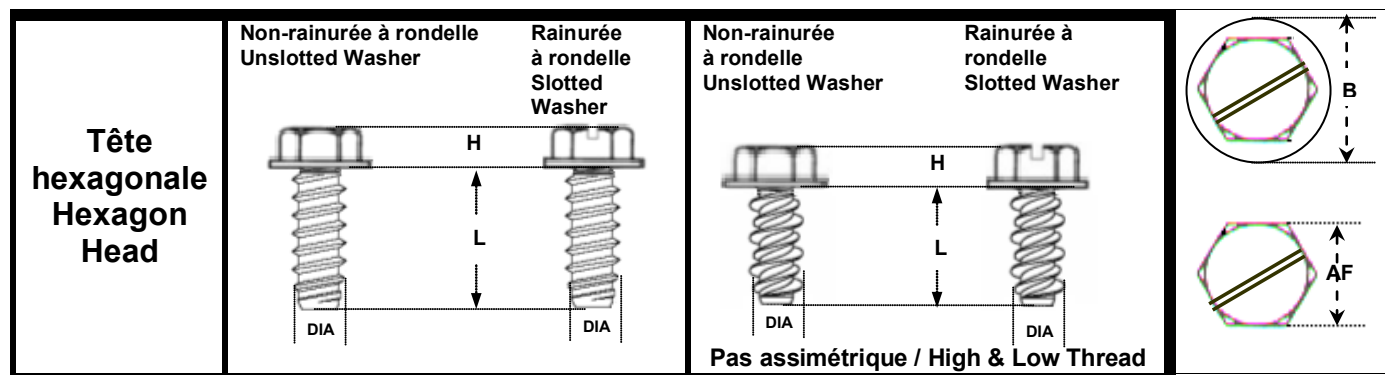

DIA	L	Acier zingué	Acier inoxydable	Acier zingué	Acier zingué	Acier inoxydable	Acier zingué	Vrac Bulk	Boîte Pkg
		Steel Zinc Plated	Stainless Steel	Steel Zinc Plated	Steel Zinc Plated	Stainless Steel 410	Steel Zinc Plated		
#4	1/4			0265 0412				10 000	100
	3/8			0265 0416				10 000	100
	1/2			0265 0418				10 000	100
	5/8			0265 0420				8 000	100
	3/4			0265 0422				8 000	100
#6	1/4			0265 0612				10 000	100
	5/16			0265 0614				10 000	100
	3/8			0265 0616				10 000	100
	1/2			0265 0618				10 000	100
	5/8			0265 0620				8 000	100
	3/4			0265 0622				7 000	100
	1			0265 0624				5 000	100
	1-1/4			0265 0626				5 000	100
1-1/2			0265 0628				4 000	100	
#8	1/4			0265 0812				10 000	100
	5/16			0265 0814				8 000	100
	3/8			0265 0816				8 000	100
	1/2			0265 0818				7 000	100
	5/8			0265 0820				6 000	100
	3/4			0265 0822				6 000	100
	1			0265 0824				4 000	100
	1-1/4			0265 0826				3 000	100
	1-1/2			0265 0828				2 500	100
	1-3/4			0265 0830				2 000	100
2			0265 0832				1 800	100	

	#4	#6	#8
AF	3/16	1/4	1/4
B	.243	.328	.348
H	.060	.093	.110

# Vis à métal Type B

## Type B Metal Screw

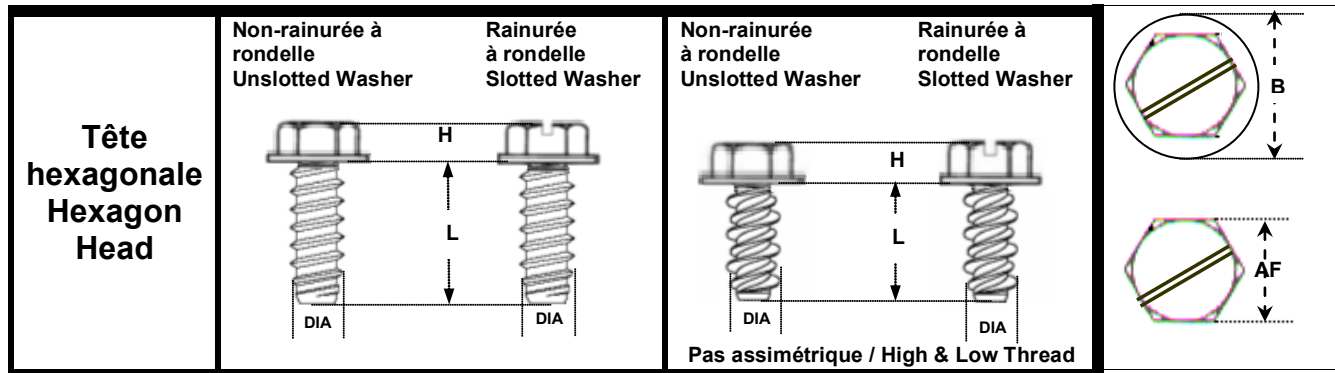

DIA	L	Acier zingué Steel Zinc Plated	Acier inoxydable Stainless Steel	Acier zingué Steel Zinc Plated	Acier zingué Steel Zinc Plated	Acier inoxydable Stainless Steel 410	Acier zingué Steel Zinc Plated	Vrac Bulk	Boîte Pkg
<b>#10</b>	3/8			0265 1016				5 000	100
	1/2			0265 1018				5 000	100
	5/8			0265 1020				4 000	100
	3/4			0265 1022				4 000	100
	1			0265 1024				3 000	100
	1-1/4			0265 1026				2 000	100
	1-1/2			0265 1028				2 000	100
	1-3/4			0265 1030				2 000	100
2			0265 1032				1 000	100	
<b>#12</b>	3/8			0265 1216				4 000	100
	1/2			0265 1218				4 000	100
<b>#14</b>	3/8			0265 2516				3 000	100
	1/2			0265 2518				3 000	100
	5/8			0265 2520				3 000	100
	3/4			0265 2522				2 500	100
	1			0265 2524				1 000	100
	1-1/4			0265 2526				1 000	100
	1-1/2			0265 2528				1 000	100
	1-3/4			0265 2530				1 000	100
	2			0265 2532				900	100
2-1/2			0265 2536				700	100	
<b>5/16</b>	1/2			0265 3118				500	100
	3/4			0265 3122				500	100
	1			0265 3124				500	100
	1-1/4			0265 3126				300	100
<b>3/8</b>	3/4			0265 3722				200	100
	1			0265 3724				200	100

	#10	#12	#14	5/16	3/8
<b>AF</b>	5/16	5/16	3/8	1/2	9/16
<b>B</b>	.414	.432	.520	.676	.780
<b>H</b>	.120	.150	.190	.230	.295

# Fausse-vis Type U

## Type U Drive Screw

<b>L</b>	1/8	<b>S</b>	.047
	3/16		.047
	1/4		.047
	5/16		.047
	3/8		.062
	1/2		.062
	5/8		.078
	3/4		.078
	1		.125

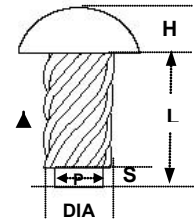
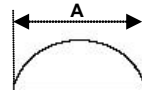

DIA	L	Acier durci zingué Hardened Steel Zinc Plated	Acier inoxydable Stainless Steel	Vrac Bulk	Boîte Pkg
<b>#00</b>	1/8	0221 0006	5077 0006	10 000	100
	3/16	0221 0010	5077 0008	10 000	100
	1/4	0221 0012	5077 0012	10 000	100
	5/16			10 000	100
	3/8			10 000	100
	1/2			10 000	100
<b>#0</b>	1/8	0221 0106	5077 0106	10 000	100
	3/16	0221 0110	5077 0108	10 000	100
	1/4	0221 0112	5077 0112	10 000	100
	5/16			10 000	100
	3/8			10 000	100
	1/2			10 000	100
<b>#2</b>	1/8	0221 0206	5077 0206	10 000	100
	3/16	0221 0210	5077 0208	10 000	100
	1/4	0221 0212	5077 0212	10 000	100
	5/16	0221 0214		10 000	100
	3/8	0221 0216	5077 0216	10 000	100
	1/2			10 000	100
<b>#4</b>	1/8	0221 0406		10 000	100
	3/16	0221 0408	5077 0408	10 000	100
	1/4	0221 0412	5077 0412	10 000	100
	5/16	0221 0414	5077 0414	10 000	100
	3/8	0221 0416	5077 0416	10 000	100
	1/2	0221 0418		10 000	100
	5/8			10 000	100
<b>#6</b>	1/8			10 000	100
	3/16		5077 0608	10 000	100
	1/4	0221 0612	5077 0612	10 000	100
	5/16	0221 0614	5077 0614	10 000	100
	3/8	0221 0616	5077 0616	10 000	100
	1/2	0221 0618	5077 0618	10 000	100
	5/8			10 000	100
	3/4			8 000	100
	1			6 000	100

	<b>#00</b>	<b>#0</b>	<b>#2</b>	<b>#4</b>	<b>#6</b>
<b>A</b>	.099/.090	.127/.118	.162/.146	.211/.193	.260/.240
<b>H</b>	.034/.036	.049/.041	.069/.059	.086/.075	.103/.090
<b>P</b>	.049/.046	.063/.060	.083/.080	.096/.092	.116/.112
<b>Diamètre du trou à percer / Recommended Hole Size</b>					
	.052	.067	.086	.104	.120
<b>Mèche # / Drill Size #</b>					
	55	51	44	37	31

# Fausse-vis Type U Type U Drive Screw

<b>L</b>	1/8	<b>S</b>	.047
	3/16		.047
	1/4		.047
	5/16		.047
	3/8		.062
	1/2		.062
	5/8		.078
	3/4		.078
	1		.125

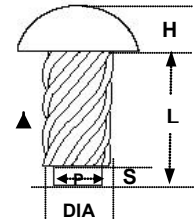
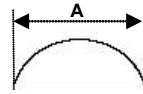

DIA	L	Acier durci zingué Hardened Steel Zinc Plated	Acier inoxydable Stainless Steel	Vrac Bulk	Boîte Pkg
<b>#7</b>	1/4	0221 0712		10 000	100
	5/16	0221 0714		10 000	100
	3/8	0221 0716		10 000	100
	1/2	0221 0718		10 000	100
<b>#8</b>	3/16			10 000	100
	1/4	0221 0812	5077 0812	10 000	100
	5/16			10 000	100
	3/8	0221 0816	5077 0816	8 000	100
	1/2	0221 0818	5077 0818	7 000	100
	5/8	0221 0820		7 000	100
	3/4			5 000	100
1			5 000	100	
<b>#10</b>	1/4			10 000	100
	3/8	0221 1016	5077 1016	5 000	100
	1/2	0221 1018	5077 1018	5 000	100
	5/8	0221 1020		5 000	100
	3/4			3 000	100
	1			3 000	100
<b>#12</b>	3/8			5 000	100
	1/2	0221 1218		5 000	100
	5/8	0221 1220		4 000	100
	3/4	0221 1222		3 000	100
	1			2 000	100
<b>#14</b>	3/8			3 000	100
	1/2	0221 2518		3 000	100
	5/8	0221 2520		2 000	100
	3/4	0221 2522		2 000	100
	1			2 000	100

	#7	#8	#10	#12	#14
<b>A</b>	.285/.264	.309/.287	.359/.334	.408/.382	.457/.427
<b>H</b>	.111/.099	.120/.107	.137/.123	.153/.139	.170/.155
<b>P</b>	.126/.122	.136/.132	.150/.146	.177/.173	.202/.198
<b>Diamètre du trou à percer / Recommended Hole Size</b>					
	.136	.144	.161	.191	.221
<b>Mèche # / Drill Size #</b>					
	29	27	20	11	2

# Vis auto-taraudeuse Type 25 Type 25 Thread Cutting Screw

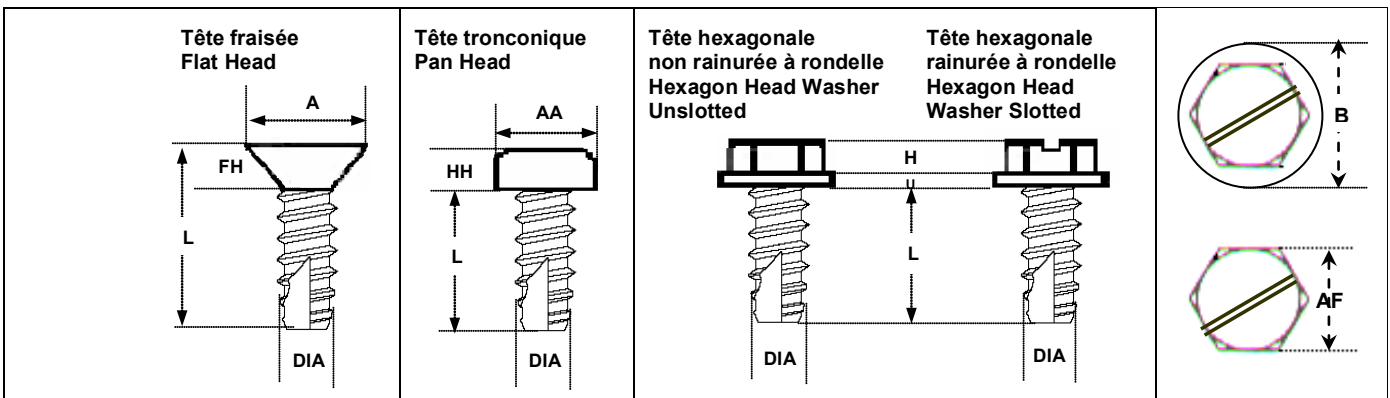

DIA	L	Acier zingué Steel Zinc Plated	Acier zingué Steel Zinc Plated	Acier zingué Steel Zinc Plated	Acier zingué Steel Zinc Plated	Vrac Bulk	Boîte Pkg
		Phillips ⊕	Phillips ⊕				
#2	3/16					10 000	100
	1/4					10 000	100
	5/16					10 000	100
	3/8					10 000	100
	1/2					10 000	100
#4	3/16					10 000	100
	1/4					10 000	100
	5/16					10 000	100
	3/8					10 000	100
	7/16					10 000	100
	1/2					10 000	100
	5/8					10 000	100
	3/4					10 000	100
	7/8					10 000	100
	1					10 000	100
1-1/4					5 000	100	
#5	1/2					10 000	100
#6	1/4					10 000	100
	5/16					10 000	100
	3/8					10 000	100
	1/2	0465 0618				10 000	100
	5/8					9 000	100
	3/4					8 000	100
	7/8					7 000	100
	1					6 000	100
	1-1/4					5 000	100
1-1/2					3 500	100	

	#2	#4	#5	#6
A	.172	.225	.252	.279
AA	.167	.219	.245	.270
AF	1/8	3/16	3/16	1/4
B	.166	.243	.260	.328
H	.050	.060	.070	.093
FH	.051	.067	.075	.083
HH	.062	.080	.089	.097
U	.016	.019	.025	.028

# Vis auto-taraudeuse Type 25 Type 25 Thread Cutting Screw

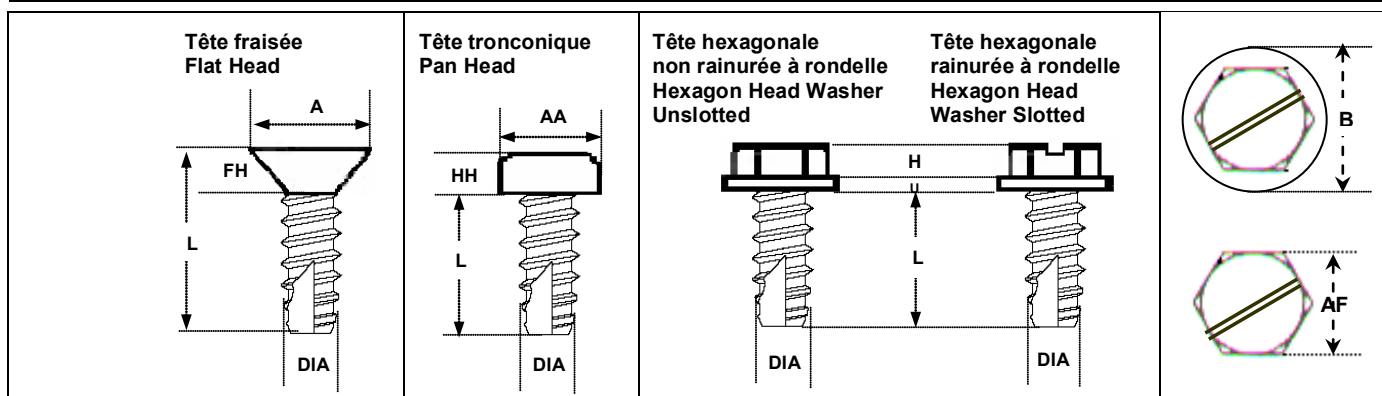

DIA	L	Acier zingué Steel Zinc Plated	Acier zingué Steel Zinc Plated	Acier zingué Steel Zinc Plated	Acier zingué Steel Zinc Plated	Vrac Bulk	Boîte Pkg
		Phillips ⊕	Phillips ⊕				
#8	1/4					10 000	100
	5/16					9 000	100
	3/8					8 000	100
	1/2					7 000	100
	5/8					6 000	100
	3/4					6 000	100
	7/8					5 000	100
	1					4 000	100
1-1/4					4 000	100	
#10	3/8					5 000	100
	1/2					5 000	100
	5/8					4 000	100
	3/4	0465 1022				4 000	100
	1					3 000	100
	1-1/4					3 000	100
1-1/2					2 000	100	
#12	1/2					2 000	100
#14	3/8					3 000	100
	1/2					2 000	100
	5/8					2 000	100
	3/4					2 000	100
	1					2 000	100
5/16	3/4					1 000	100
	1					1 000	100
	1-1/2					500	100
3/8	1					600	100

	#8	#10	#12	#14	5/16	3/8
A	.332	.385	.438	.507	.635	.762
AA	.322	.373	.425	.492	.615	.740
AF	1/4	5/16	5/16	3/8	1/2	9/16
B	.348	.414	.432	.520	.676	.780
H	.110	.120	.155	.190	.230	.295
FH	.100	.116	.132	.153	.191	.230
HH	.115	.133	.151	.175	.218	.261
U	.031	.031	.039	.050	.055	.063

# Vis triangulaire auto-taraudeuse Thread Rolling Screw

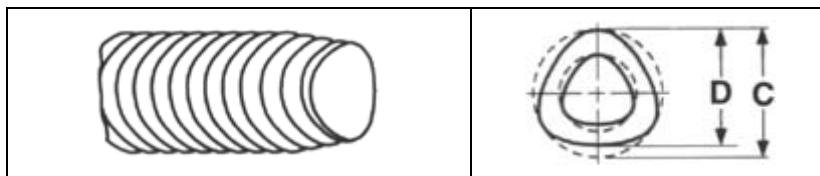

Zingué Zinc Plated		Tête fraisée Flat Head	Tête tronconique Pan Head	Tête hexagonale Hexagon Head	
		Phillips ⊕	Phillips ⊕	⬠	
DIA	L				
<b>2-56</b>	3/16		0371 0210		C .0875/.0835 D .0840/.0800
	1/4		0371 0212		
	5/16		0371 0214		
	3/8		0371 0216		
	7/16		0371 0217		
	1/2		0371 0218		
<b>4-40</b>	3/16		0371 0408		C .1145/.1105 D .1095/.1055
	1/4	0370 0412	0371 0412	0372 0412	
	5/16	0370 0414	0371 0414	0372 0414	
	3/8	0370 0416	0371 0416	0372 0416	
	7/16	0370 0417	0371 0417	0372 0417	
	1/2	0370 0418	0371 0418	0372 0418	
	5/8	0370 0420	0371 0420	0372 0420	
	3/4		0371 0422		
	1		0371 0424		
	1-1/4		0371 0426		
<b>6-32</b>	3/16		0371 0608		C .1410/.1350 D .1350/.1290
	1/4	0370 0612	0371 0612	0372 0612	
	5/16	0370 0614	0371 0614	0372 0614	
	3/8	0370 0616	0371 0616	0372 0616	
	7/16		0371 0617	0372 0617	
	1/2	0370 0618	0371 0618	0372 0618	
	5/8	0370 0620	0371 0620	0372 0620	
	3/4	0370 0622	0371 0622	0372 0622	
	7/8		0371 0623		
	1		0371 0624	0372 0624	
	1-1/4		0371 0626	0372 0626	
	1-1/2		0371 0628		
<b>8-32</b>	3/16		0371 0808		C .1670/.1610 D .1610/.1550
	1/4	0370 0812	0371 0812	0372 0812	
	5/16		0371 0814	0372 0814	
	3/8	0370 0816	0371 0816	0372 0816	
	7/16		0371 0817		
	1/2	0370 0818	0371 0818	0372 0818	
	5/8	0370 0820	0371 0820	0372 0820	
	3/4	0370 0822	0371 0822	0372 0822	
	7/8		0371 0823	0372 0823	
	1	0370 0824	0371 0824	0372 0824	
	1-1/4		0371 0826	0372 0826	
	1-1/2	0370 0828	0371 0828		



# Vis triangulaire auto-taraudeuse Thread Rolling Screw

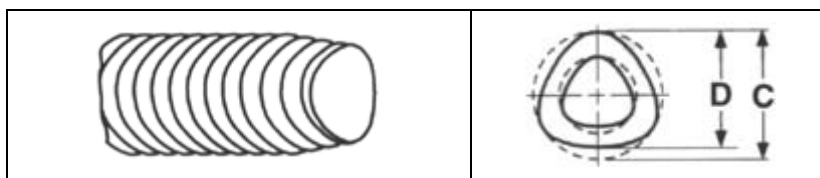

Zingué Zinc Plated		Tête fraisée Flat Head	Tête tronconique Pan Head	Tête hexagonale Hexagon Head	
		Phillips ⊕	Phillips ⊕	⬠	
DIA	L				
<b>10-24</b>	1/4		0371 1012		C .1940/.1880 D .1850/.1790
	3/8	0370 1016	0371 1016	0372 1016	
	1/2	0370 1018	0371 1018	0372 1018	
	5/8	0370 1020	0371 1020	0372 1020	
	3/4	0370 1022	0371 1022	0372 1022	
	7/8		0371 1023	0372 1023	
	1	0370 1024	0371 1024	0372 1024	
	1-1/4		0371 1026	0372 1026	
1-1/2		0371 1028	0372 1028		
<b>10-32</b>	1/4		0371 1112		C .1930/.1870 D .1870/.1810
	5/16		0371 1114		
	3/8	0370 1116	0371 1116	0372 1116	
	7/16		0371 1117		
	1/2	0370 1118	0371 1118	0372 1118	
	5/8	0370 1120	0371 1120	0372 1120	
	3/4	0370 1122	0371 1122	0372 1122	
	7/8		0371 1123		
	1	0370 1124	0371 1124	0372 1124	
	1-1/4		0371 1126	0372 1126	
1-1/2		0371 1128	0372 1128		
1-3/4		0371 1130	0372 1130		
<b>12-24</b>	3/8			0372 1216	C .2200/.2140 D .2110/.2050
	1/2		0371 1218	0372 1218	
	5/8			0372 1220	
	3/4			0372 1222	
	1		0371 1224		
<b>1/4-20</b>	3/8		0371 2516	0372 2516	C .2550/.2490 D .2460/.2400
	1/2	0370 2518	0371 2518	0372 2518	
	5/8	0370 2520	0371 2520	0372 2520	
	3/4	0370 2522	0371 2522	0372 2522	
	7/8			0372 2523	
	1	0370 2524	0371 2524	0372 2524	
	1-1/4	0370 2526	0371 2526	0372 2526	
	1-1/2		0371 2528	0372 2528	
	1-3/4		0371 2530	0372 2530	
	2		0371 2532	0372 2532	
	2-1/2			0372 2536	
3			0372 2540		

# Vis triangulaire auto-taraudeuse Thread Rolling Screw

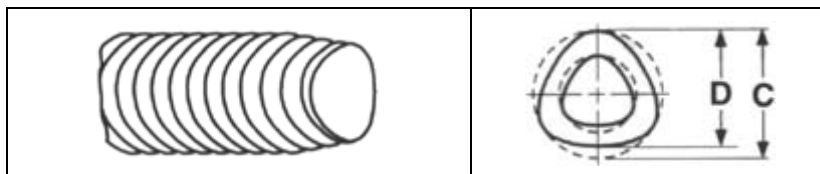

Zingué Zinc Plated		Tête fraisée Flat Head	Tête tronconique Pan Head	Tête hexagonale Hexagon Head	
		Phillips ⊕	Phillips ⊕	⬠	
DIA	L				
5/16-18	1/2			0372 3118	C .3180/.3120 D .3080/.3020
	5/8			0372 3120	
	3/4		0371 3122	0372 3122	
	1			0372 3124	
	1-1/4			0372 3126	
	1-1/2			0372 3128	
	1-3/4			0372 3130	
	2			0372 3132	
3/8-16	1/2			0372 3718	C .3810/.3750 D .3710/.3650
	5/8			0372 3720	
	3/4			0372 3722	
	7/8			0372 3723	
	1			0372 3724	
	1-1/4			0372 3726	
	1-1/2			0372 3728	
	2			0372 3732	
1/2-13	1			0372 5024	C .5075/.5015 D .4935/.4875
	1-1/2			0372 5028	

# Vis taraudeuse à pas assymétrique Tapping Screw High Low

## Tête tronconique Pan Head

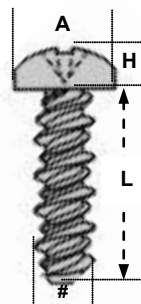

L \ #	Acier zingué / Steel Zinc Plated							
	#2	#4	#5	#6	#8	#10	#12	#14
3/16	0292 0210	0292 0408						
1/4	0292 0212	0292 0412		0292 0612	0292 0812			
5/16	0292 0214	0292 0414		0292 0614	0292 0814			
3/8	0292 0216	0292 0416	0292 0516	0292 0616	0292 0816	0292 1016		
1/2	0292 0218	0292 0418		0292 0618	0292 0818	0292 1018		0292 2518
5/8		0292 0420		0292 0620	0292 0820	0292 1020		
3/4		0292 0422		0292 0622	0292 0822	0292 1022		0292 2522
7/8				0292 0623				
1				0292 0624	0292 0824	0292 1024		0292 2524
1-1/8					0292 0825			
1-1/4				0292 0626	0292 0826	0292 1026		
1-1/2				0292 0628	0292 0828	0292 1028		
2						0292 1032		

<b>A</b>	.167	.219	.245	.270	.322	.373	.425	.492
<b>H</b>	.053	.068	.075	.082	.096	.110	.125	.144

# Vis taraudeuse à pas assymétrique Tapping Screw High Low

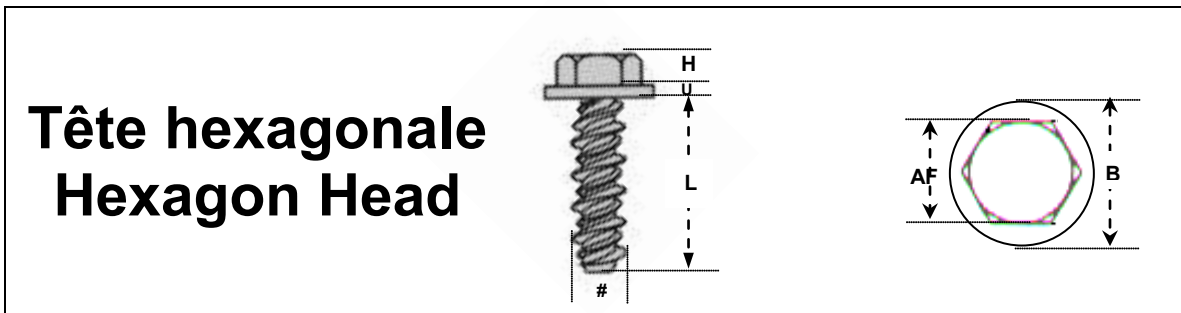

L \ #	Acier zingué / Steel Zinc Plated					
	#4	#6	#8	#10	#12	#14
1/4	0293 0412	0293 0612	0293 0812			
5/16	0293 0414	0293 0614				
3/8	0293 0416	0293 0616	0293 0816	0293 1016		
1/2	0293 0418	0293 0618	0293 0818	0293 1018		0293 2518
5/8			0293 0820	0293 1020		
3/4			0293 0822	0293 1022	0293 1222	0293 2522
1						0293 2524

<b>AF</b>	3/16	1/4	1/4	5/16	5/16	7/16
<b>B</b>	.243	.328	.348	.414	.432	.520
<b>H</b>	.060	.093	.110	.120	.155	.190
<b>U</b>	.019	.025	.031	.031	.039	.050